

208~230V Super High Fan Coil

Model:GMV-ND18PHS/B-T(U)



Specifications	Unit	Parameter
Model	—	GMV-ND18PHS/B-T(U)
Performance		
Rated Cooling Capacity	kBtu/h	18
Rated Heating Capacity	kBtu/h	20
Sound Pressure Level	dB(A)	35/38/42
Electrical Data		
Power Supply	Voltage,Phase, Hertz	208/230,1,60
Maximum Overcurrent Protection (MOP)	A	15
Minimum Circuit Amps (MCA)	A	1
Fan		
Type × Quantity	—	Centrifugal ×2
Air Flow Volume	CFM	411/470/588
ESP	Pa	90/0~200
Fan Motor Running Current	A	0.7
Fan Motor Power Output	W	200
Refrigerant Piping		
Connection Pipe	Gas(mm/inch)	Φ15.9/Φ5/8
	Liquid(mm/inch)	Φ9.52/Φ3/8
Connection method	—	Brazing Connection
Refrigerant	—	R410A
Dimension/Weight		
Dimensions (H×W×D)	mm/inch	300×1000×700/ (11-13/16×39-3/8×27-9/16)
Net Weight	kg/lbs	42.6/94
Other		
Safety Certification	—	ETL

Job Name:		Date:	
System Reference No.:			
Engineer Signature:			

Outline and Physical Dimensions of GMV-ND18PHS/B-T(U).

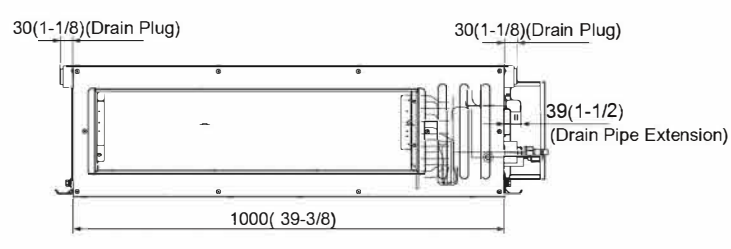
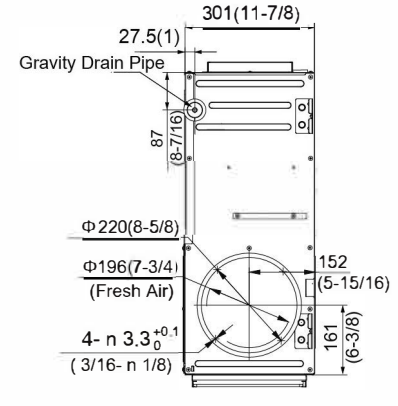
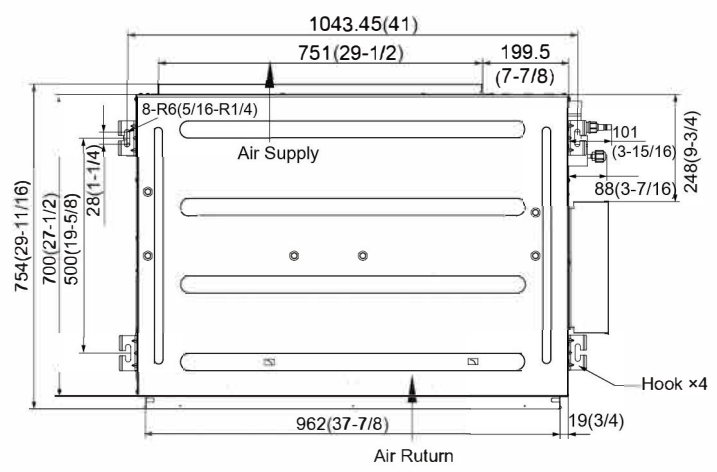
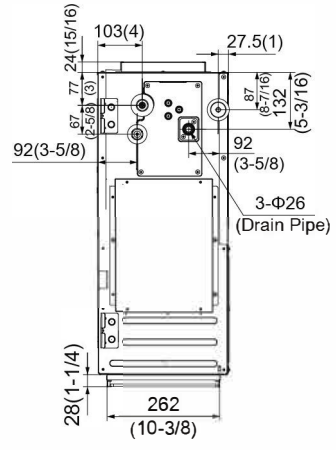
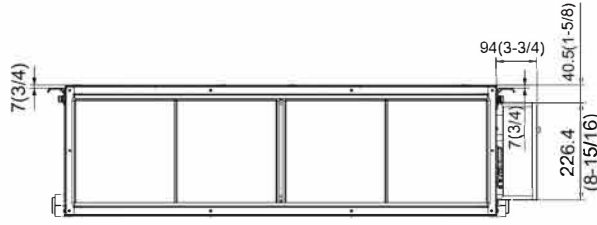

Model	Gas Pipe Diameter	Liquid Pipe Diameter
GMV-ND18PHS/B-T(U)	5/8"	3/8"

Unit:mm(in.)

